



SOSEN LED Driver, Your Smart Choice

Specifications

SS-320NH-E260D LED Driver

Model: SS-320NH-E260D

Description: 320W LED Driver

Rev.: V01

Release Date: 2023-11-24

SS-320NH-E260D LED Driver

SOSEN
LED DRIVER



LED DRIVER

NH-E260D



Features:

- ❑ Efficiency up to 96%
- ❑ DALI-2
- ❑ Isolated Dim-to-off
- ❑ Standby power < 0.5W
- ❑ Protections: SCP/OTP
- ❑ Surge protection: CM: 6kV, DM: 6kV
- ❑ Warranty: 5 years



Description:

SS-320NH-E260D are 320W non-isolated constant current LED Driver with 90-305VAC. It has DIM to Off, high efficiency, compact housing, fully potted, high reliability, high cost performance and other advantages.

Applications:

Wall washers, Linear high bay, Flood lighting, Wall lamp

Model List:

Model	AC Input Range	Max. Pout	Vout Range	Full Power Vo Range	Iout	THD(Typ.)	PF(Typ.)	Eff.(Typ.)	Max.Tc
SS-320NH-E260D	90-305Vac	320W	180-260V	214V-260V	1.1-1.5A	8%	0.97	96%	90°C

Note:

1. Default Tested: at 220Vac, full load, Ta 25°C.

2. The performance of the LED Driver can be guaranteed within the full power Vo range. The voltage lower than full power Vo range, it is need to test the performance with the LED module;

SS-320NH-E260D LED Driver

Input Characteristics:

Parameter	Min.	Typ.	Max.	Remark
Rated AC Input Range	100Vac		277Vac	Ref. derating curve
AC Input Range	90Vac		305Vac	Ref. derating curve
Input Frequency Range	47Hz	50/60Hz	63Hz	
Max Input Current			3.5A	120Vac, Full load
Max Input Power			355W	120Vac, Full load
Max Inrush Current(120Vac)			80A	Cold start
Max Inrush Current(220Vac)			120A	Cold start
Max Inrush Current(277Vac)			150A	Cold start
Standby Power			0.5W	220Vac/50Hz, DALI Dim to off
Power Factor	0.95	0.97		220Vac/50Hz, Full load
	0.90			100-277Vac/50Hz, 70%-100% load
THD		8%	10%	220Vac/50Hz, Full load
			20%	100-277Vac/50Hz, 70%-100% load

SS-320NH-E260D LED Driver

Output Characteristics:

Parameter	Min.	Typ.	Max.	Remark
O/P Voltage Range	180V		260V	Power derated @180-214V
Rated O/P Voltage	214V		260V	$P_o = V_o \cdot I_o = 320W$, Full load
Rated O/P Current	1.23A		1.5A	1.5A for 214V, 1.23A for 260V
Adj. O/P Current (AOC) Range	1.1A		1.5A	
No Load Voltage			310V	
Efficiency @120Vac	91.0%	93.0%		Output 260V/1.23A
Efficiency @220Vac	94.0%	96.0%		Output 260V/1.23A
Efficiency @277Vac	94.0%	96.0%		Output 260V/1.23A
O/P Current Tolerance	-5%		+5%	
O/P Current Ripple(PK-AV)		5%	10%	Full load
Start-up Current Overshoot			10%	Full load
Start-up Time			0.7S	230Vac, Full load
Line Regulation	-2%		+2%	Full load
Load Regulation	-5%		+5%	
Temperature Coefficient	-0.05%/°C		+0.05%/°C	Tc:0°C~90°C
OTP	90°C	100°C	110°C	>Tc Typ., Current derating <Tc Min., Current recovery
Short Circuit Protection				Driver will not be damaged, Shut down

SS-320NH-E260D LED Driver

Other Characteristics:

Parameter	Min.	Typ.	Max.	Remark
DALI Dimming Level	1-170(10%)		254(100%)	Logarithmic dimming curve
DALI Dimming(Optional)	Meet DALI-2			
Lifetime($T_c \leq 85^\circ\text{C}$)	$\geq 50,000$ hours			
MTBF	200,000 hours			220Vac, Full load, $T_a = 25^\circ\text{C}$ (MIL-HDBK-217F)
T_c	90°C			
Warranty	5 years			$T_c: 75^\circ\text{C}$
Net Weight	660g			
Dimension	220mm*52.5mm*34mm			L x W x H

NOTE: All the parameters above are tested $T_a 25^\circ\text{C}$ and LED load, unless specified.

SS-320NH-E260D LED Driver

Environmental Requirements

Parameter	Min.	Typ.	Max.	Remark
Operating Temperature(Tcase)	-40°C	25°C	+90°C	
Storage Temperature	-40°C	25°C	+90°C	
Operation Humidity	10%RH		90%RH	
Storage Humidity	5%RH		95%RH	
Altitude	-65m		4000m	

Safety and EMI/EMS Standards

Certification	Standard	Status	Remark
DALI-2	IEC62386-101(2.0),102(2.0),207(2.0)	✓	
UL/cUL	UL8750		
TUV	EN 61347-2-13:2014/A1:2017 EN61347-1:2015 EN62493:2015	✓	
RCM	AS/NZS61347.2.13		
BIS	IS15885:2012 Part 2 Sec 13		
CCC	GB 19510.14-2009		
CE	EN 61347-2-13:2014 EN61347-1:2008+A1:2011+A2:2013	✓	

EMI/EMS	Criterion	Remark
Conduction Emission	EN IEC 55015:2019+A11:2020	
Radiation Emission	EN IEC 55015:2019+A11:2020	
Harmonic Current Emissions	IEC/EN 61000-3-2:2019+A1:2021	Class C
Surge	IEC/EN61000-4-5	DM: 6kV,CM: 6kV,Criterion B
Ring Wave	IEC/EN 61000-4-12	DM: 6kV,CM: 6kV,Criterion B

SS-320NH-E260D LED Driver

Safety Test Items:

Safety Test Items	Technical Indicators		Remark
Insulation Requirements	UL Insulation Requirements	TUV Insulation Requirements	
Input-Case	/	1500Vac	Basic insulation
Input-Dim	/	3000Vac	Reinforced insulation
Dim-Case	/	250Vac	Basic insulation
Insulation Resistance	$\geq 10M\Omega$		Input-Dim, Test voltage: 500Vdc
Ground Resistance	$\leq 0.1\Omega$		25A/1min
Leakage Current	$\leq 0.75mA$		277Vac

NOTE:

1. SOSEN warrants the LED Driver itself complies with EMC standard. However, LED Driver's EMC should be re-checked when integrated into lighting systems due to unexpected interference of components.
2. Please short (ACL and ACN), (V+ and V-), (Dim+ and Dim - and Vaux+ and Vaux-) when Hi-pot test.

Performance Curves:

Input Inrush Current

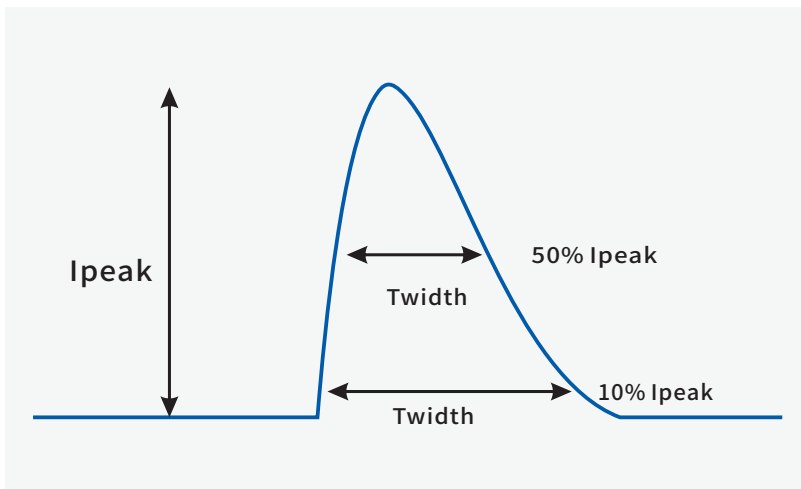

Vin	Ipeak	T(@10% of Ipeak)	T(@50% of Ipeak)
120Vac	80A	896uS	
220Vac	120A		316uS
277Vac	150A	664uS	

SS-320NH-E260D LED Driver

Performance Curves:

Output Voltage Vs. Output Current(Dim/AOC Window)

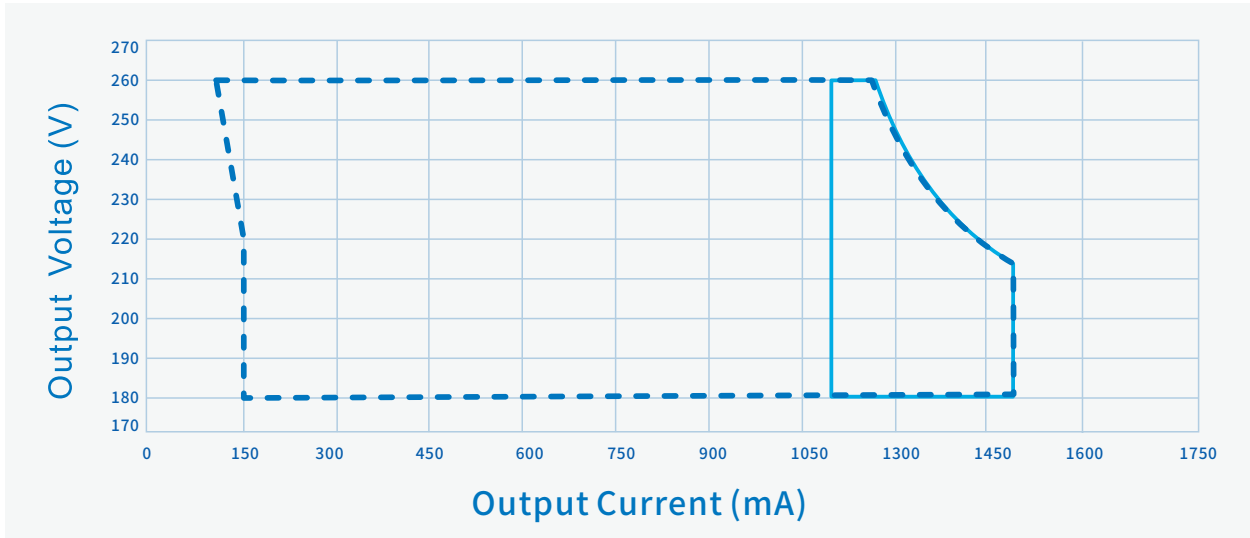

----- Dimming Window ————— AOC Window

Efficiency Vs. Output Voltage (Vin=120Vac)

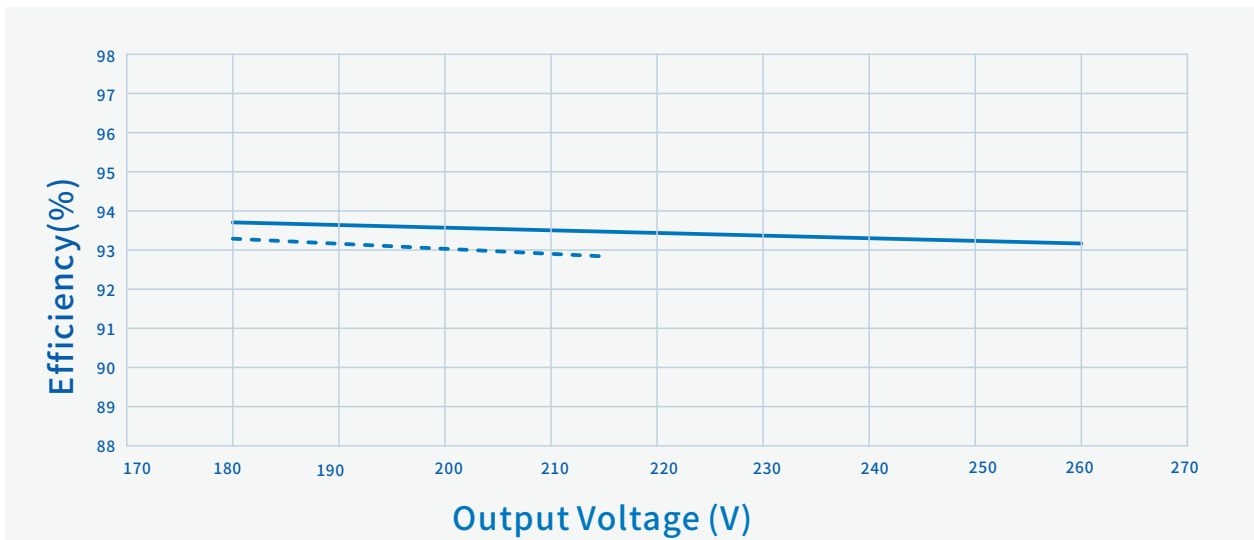

----- Io=1500mA ————— Io=1230mA

SS-320NH-E260D LED Driver

Performance Curves:

Efficiency Vs. Output Voltage ($V_{in}=220V_{ac}$)

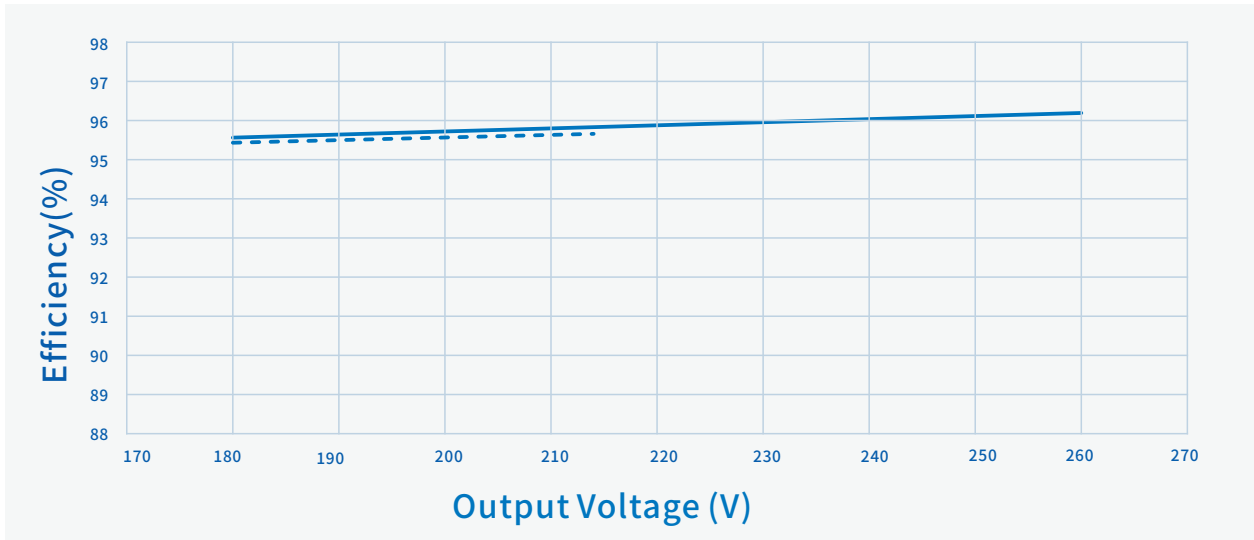

----- $I_o=1500mA$

————— $I_o=1230mA$

Efficiency Vs. Output Voltage ($V_{in}=277V_{ac}$)

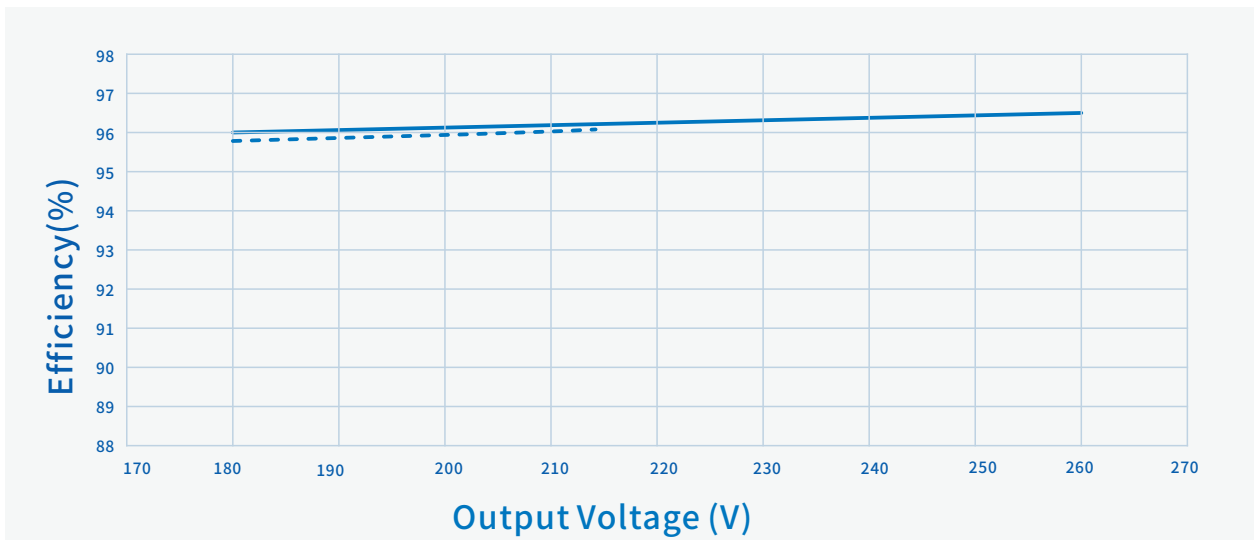

----- $I_o=1500mA$

————— $I_o=1230mA$

SS-320NH-E260D LED Driver

Performance Curves:

Power Factor Vs. Output Power

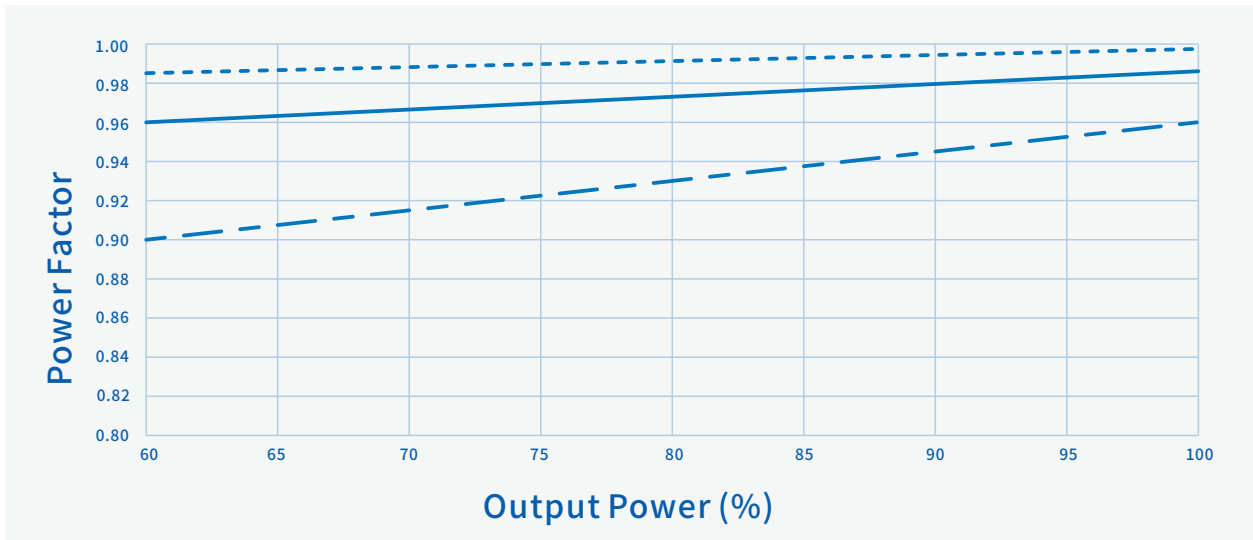

----- Vin=120Vac ——— Vin=220Vac - - - Vin=277Vac

THD Vs. Output Power

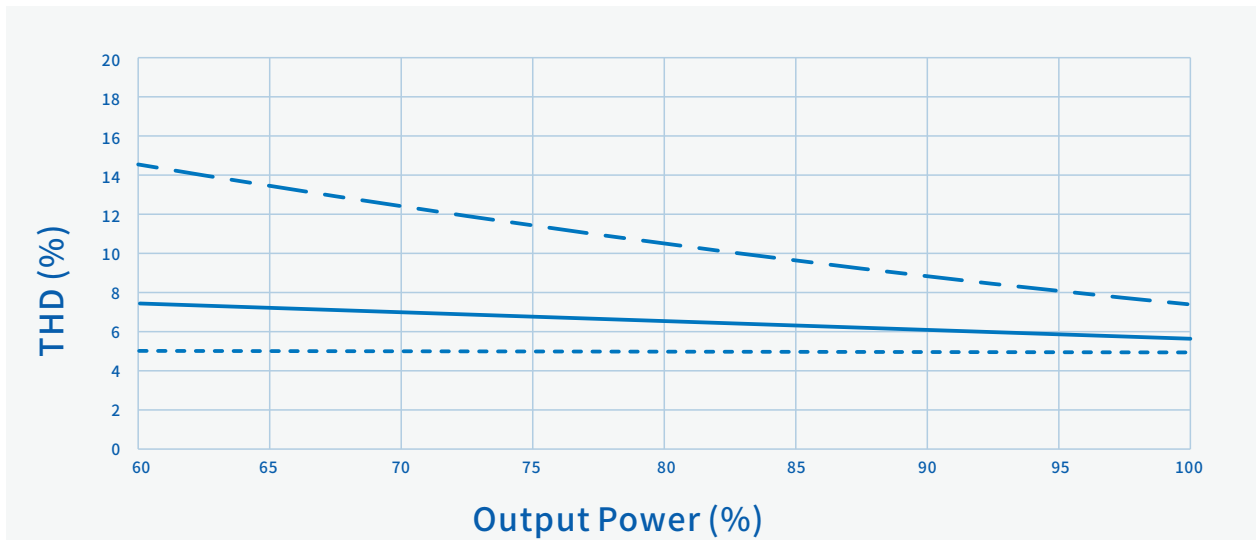

----- Vin=120Vac ——— Vin=220Vac - - - Vin=277Vac

SS-320NH-E260D LED Driver

Performance Curves:

Output Power Vs. Input Voltage

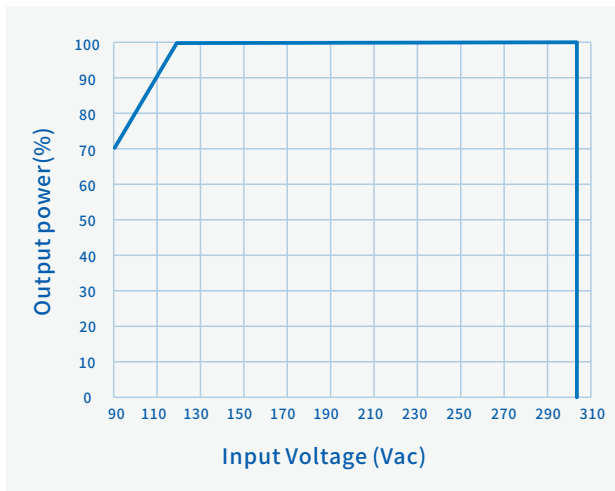

Output Power Vs. Case Temperature

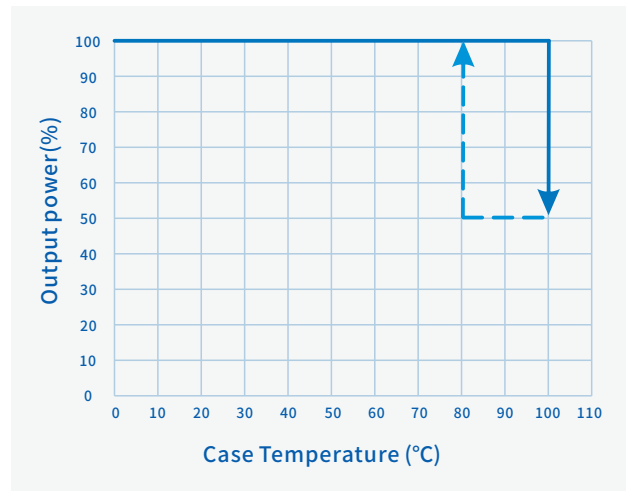

Output Power Vs. Dimming

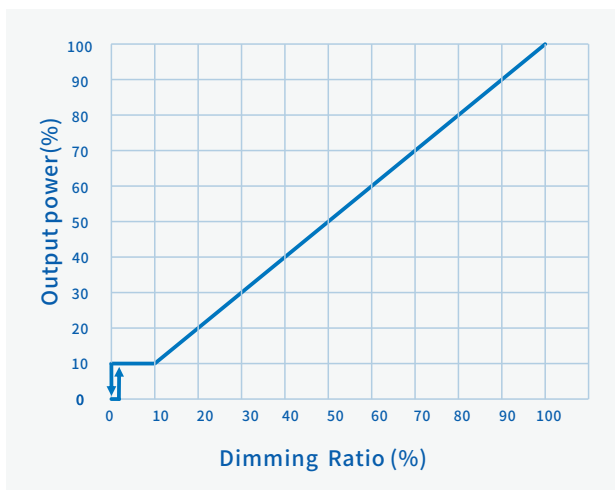

Lifetime Vs. Case Temperature

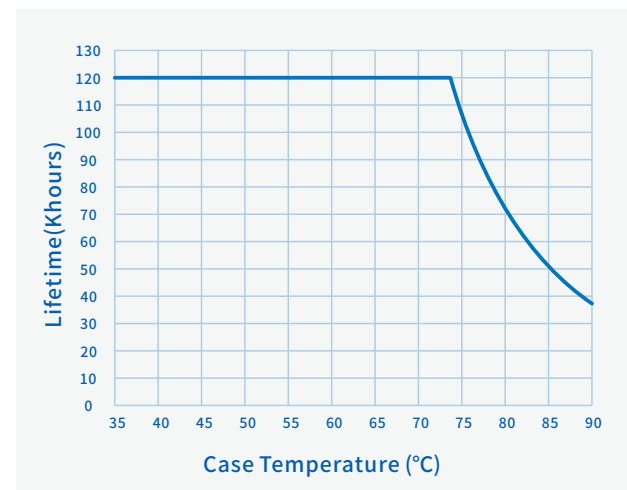

SS-320NH-E260D LED Driver

Performance Curves:

Output Power Vs. Dimming

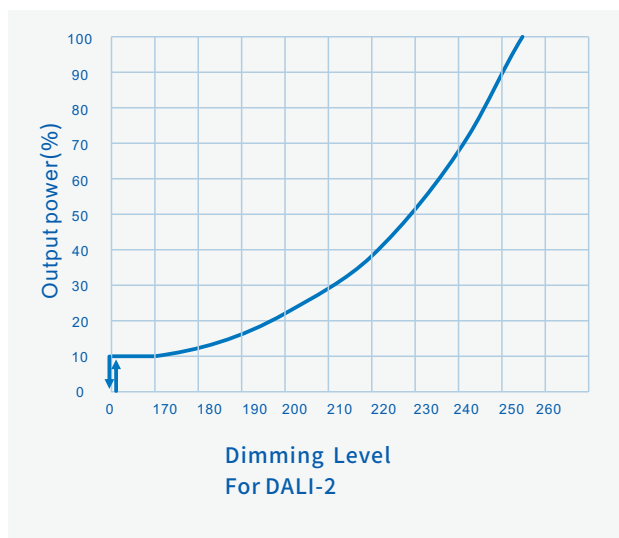

SS-320NH-E260D LED Driver

Mechanical Characteristics

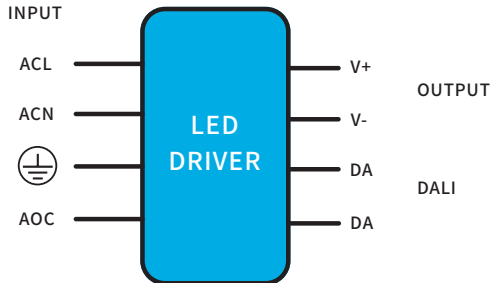

AC Input Cable(Exposed Length $300 \pm 10\text{mm}$):

UL/EU model: 18AWG 105°C 600V O.D: 2.77mm,Black:ACL,White:ACN,Green:⊕

DC Output Cable(Exposed Length $300 \pm 10\text{mm}$):

UL/EU model: 18AWG 105°C 300V O.D: 1.95mm,Red:V+, Black:V-

DALI Cable(Exposed Length $220 \pm 10\text{mm}$):

UL/EU model: 22AWG 105°C 300V O.D: 1.52mm, Purple: DA, Pink: DA

Name Description	Standard Code	mm(In.)
Case Length	L3	202(7.95)
Case Width	W3	52.5(2.07)
Case Width	W2	32(1.26)
Case Height	H	34(1.34)
Overall Length	L1	220(8.66)
Mounting Hole Length	L2	210.5(8.29)
Mounting Hole Width	W1	16(0.63)
TC Point Position	X	120(4.72)
TC Point Position	Y	17(0.67)

Note:

1,Please follow the "LED Driver User Manual" obtained from SOSEN's official website for assembly.

2,AC Input Cable,DC O/P Cable,DALI Cable:

Tinned length of wire: $10 \pm 2\text{mm}$

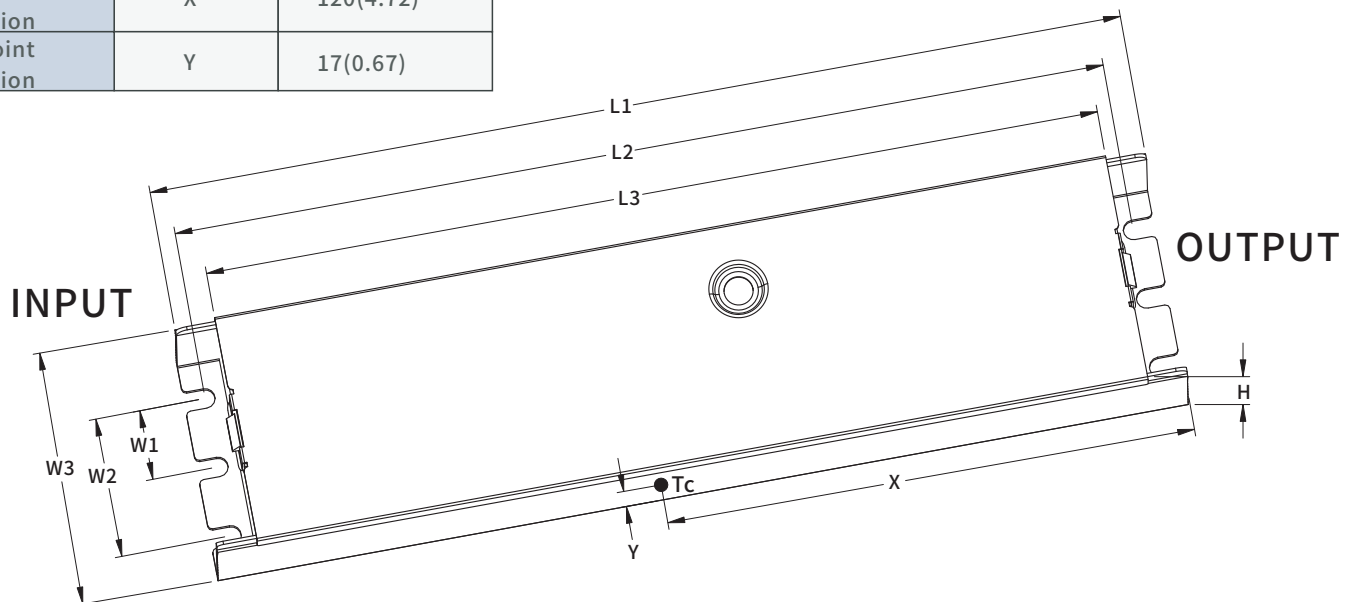

SS-320NH-E260D LED Driver



Assembly Tips

1. Highly recommended to seal the adjustable hole with silicon glue(#704 preferred) after adjusting the Driver's output current. Avoid permanent damage to adjust the potentiometer with suitable strength.
2. Dimming or AUX Power tinned connectors should be capped if not used to avoid dimming or AUX Power parts damage from external signals.
3. In order to meet the requirements of the power derating and the maximum ambient temperature of 50°C, an auxiliary heat sink must be added. It is recommended that the heat sink has a heat dissipation area of 380cm² and volume of 115cm³. Thermal grease should be applied between led driver and the auxiliary heat sink to ensure the bottom of housing is in close contact with the heat sink.
4. Safety space between aluminum base and LED coppers >5mm.
5. Safety space/coppers between LED+ and LED- >1.8mm.
6. Minimize the copper area on the aluminum PCB to reduce parasitic capacitance and leakage current.
7. It is recommended to design LED beads in parallel first and then in series.
8. When the driver shutdown by some protection, it can be restarted via AC power-on or by sending a command from the DALI master.
9. The insulation level of LED light panels should meet the reliability design requirements.
10. For other precautions, please refer to the "LED Driver User Manual" .
11. SOSEN reserves the right of final interpretation of the above parameters.

Package

- Outside carton dimension: L×W×H=495mm×385mm×162mm;
- 16PCS/Carton;
- Net weight/Piece: 0.66kg;Gross weight/Carton: 12kg;
- Please refer to the product name, model number, manufacturer identification, QC PASS, manufacturing date on the package.

Transportation

Packaging is designed suitable for transportation by trucks, vessels and flights. The products should be avoided direct sunlight and rain, loaded/unloaded with caution.

Storage

The product storage meets the standard of the GB 3873—83.
Products should be rechecked if stored for over 1 year before assembly.

RoHS

Products comply with RoHS Directive (2011/65/EU) and amendment 2015/863/EU.

Revision History

Version	Description of Update	Updated Date	Remark
V00	Original Release	2023/03/09	
V01	Update Assembly Tips	2023/05/22	
V02	Update Lifetime	2023/11/24	